

# ULTRA SA

Self-priming



Self-priming horizontal multistage stainless steel pumps suitable for domestic use, also in combination with autoclave tank. Suitable for drinking water or glycol, for water treatment, heating, air conditioning and washing systems.

## Construction features

<b>Pump body, mechanical seal housing</b>	stainless steel AISI 304
<b>Motor bracket</b>	aluminum
<b>Impellers, diffusers</b>	stainless steel AISI 304
<b>Mechanical seal</b>	ceramic-graphite-EPDM
<b>Motor shaft</b>	stainless steel AISI 303
<b>Liquid temperature</b>	-15 ÷ +110 °C
<b>Operating pressure</b>	max 7 bar

## Motor

	3~ 230/400V-50Hz
<b>2 poles induction motor</b>	1~ 230V-50Hz (with thermal protection up to 1.85 kW)
<b>Insulation class</b>	F
<b>Protection degree</b>	IPX4

## U 3 S A - 100/5 T

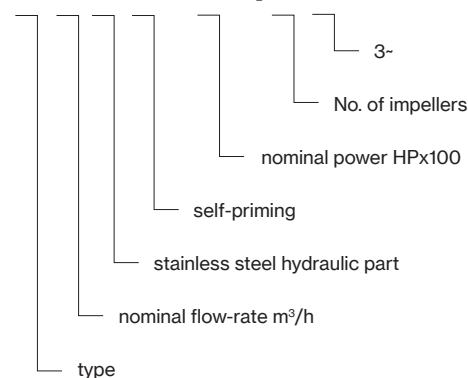

TYPE	TRUCK		CONTAINER	
	PALLET (cm)	N° pumps	PALLET (cm)	N° pumps
<b>U 3SA-90/4</b>	85×110×160	70	85×110×185	80
<b>U 3SA-100/5</b>	80×120×150	42	80×120×175	49
<b>U 5SA-120/4</b>	80×120×150	42	80×120×175	49
<b>U 5SA-150/5</b>	80×120×150	42	80×120×175	49

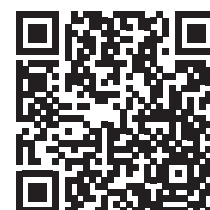

# ULTRA SA

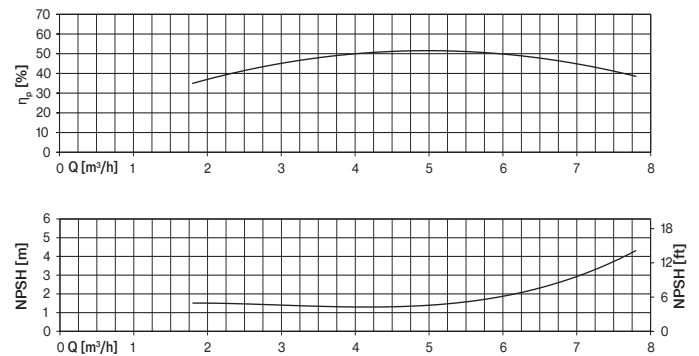
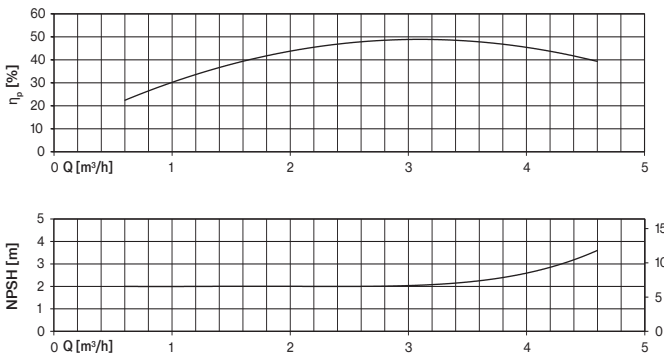
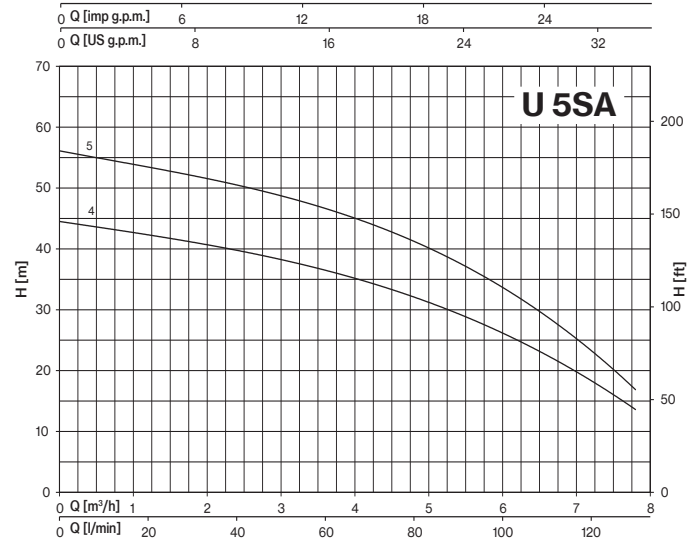
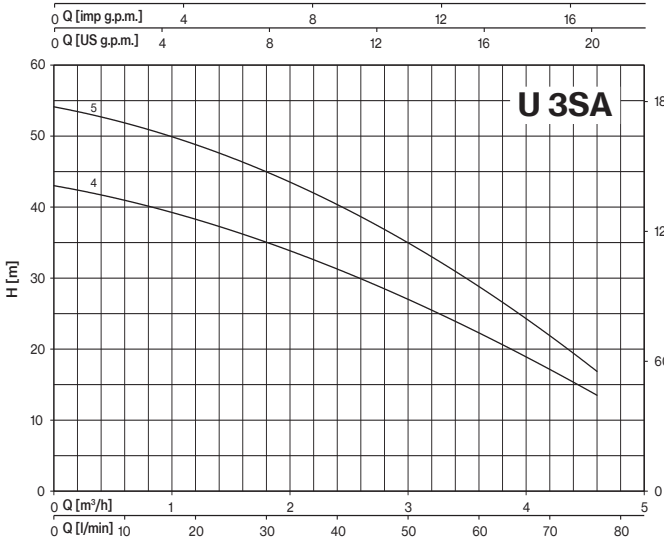

TYPE		P2		P1 (kW)		AMPERE		Q (m³/h - l/min)										
1~	3~	HP	kW	1~	3~	1~ 1x230 V 50 Hz	3~ 3x400 V 50 Hz	0	0,6	1,2	1,8	2,4	3,6	4,6	4,8	6	7	7,8
								0	10	20	30	40	60	76,7	80	100	116,7	130
U 3SA-90/4	U 3SA-90/4 T	0,9	0,66	0,83	0,8	3,6	1,7	43,0	41,0	38,3	35,0	31,3	22,3	13,5				
U 3SA-100/5	U 3SA-100/5 T	1	0,75	0,99	0,92	4,4	1,7	54,0	52,1	48,8	44,9	40,2	29,0	16,8				
U 5SA-120/4	U 5SA-120/4 T	1,2	0,9	1,09	1,08	4,9	2,4	44,5			41,0	40,0	36,4	32,8	32,0	26,2	18,5	13,5
U 5SA-150/5	U 5SA-150/5 T	1,5	1,1	1,39	1,31	6,5	2,7	56,0			52,4	50,5	46,4	42,0	41,0	33,8	23,8	16,5

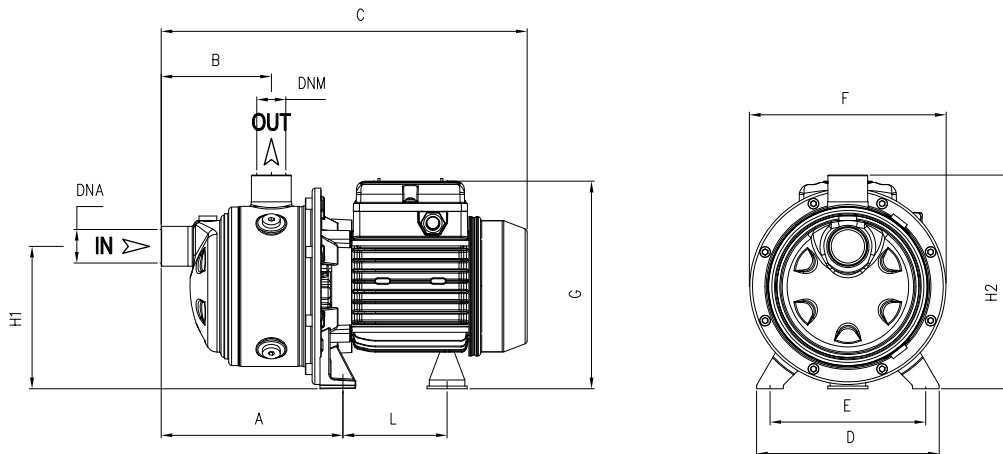

TYPE	DIMENSIONS (mm)											DNA	DNM	Kg
	A	B	C	D	E	F	G	L	H1	H2				
U 3SA-90/4	238,8	175	405	164	140	178	190	93,7	128	192	1" G	1" G	10	
U 3SA-100/5	262,8	199	452	164	140	178	203	104,7	128	192			12,5	
U 5SA-120/4	238,8	175	428	164	140	178	203	104,7	128	192			12,5	
U 5SA-150/5	262,8	199	514	164	140	201	211	128,2	134	198	15,5			

