



Pompe centrifughe che abbinano medie prevalenze a portate medio alte; adatte per irrigazioni a pioggia e in generale dove oltre alla silenziosità viene richiesta una lieve oscillazione di pressione al variare della portata.

Centrifugal pumps that combine medium head with medium-high delivery; ideal for sprinkle irrigation and in applications where quiet operations are requested and only slight pressure change as the delivery changes.

Bombas centrífugas que combinan prevalencias medias con caudales medio-altos; apropiadas para riegos por aspersión en general donde además del silencio se solicita una leve oscilación de presión cuando varía el caudal.

Pompes centrifuges qui associent des hauteurs manométriques moyennes à des débits moyens-élevés; adaptées pour l'irrigation par aspersion et, en général, quand, en plus du bruit limité, il faut assurer une légère oscillation de pression en fonction de la variation du débit.

**CARATTERISTICHE COSTRUTTIVE / CONSTRUCTION FEATURES  
CARACTERÍSTICAS CONSTRUCTIVAS / CARACTÉRISTIQUES D'EXÉCUTION**

<b>Corpo pompa</b>	ghisa
<b>Pump body</b>	cast iron
<b>Cuerpo bomba</b>	fundición
<b>Corps de pompe</b>	fonte
<b>Supporto motore</b>	ghisa
<b>Motor bracket</b>	cast iron
<b>Soporte motor</b>	fundición
<b>Support moteur</b>	fonte
<b>Girante</b>	ottone (CH 160-310) ghisa (CH 350-550)
<b>Impeller</b>	brass (CH 160-310) cast iron (CH 350-550)
<b>Rodete</b>	latón (CH 160-310) fundición (CH 350-550)
<b>Turbine</b>	laiton (CH 160-310) fonte (CH 350-550)
<b>Tenuta meccanica</b>	ceramica-grafite
<b>Mechanical seal</b>	ceramic-graphite
<b>Sello mecánico</b>	cerámica-grafito
<b>Garniture mécanique</b>	céramique-graphite
<b>Albero motore</b>	acciaio AISI 303
<b>Motor shaft</b>	stainless steel AISI 303
<b>Eje motor</b>	acero AISI 303
<b>Arbre moteur</b>	acier AISI 303
<b>Temperatura del liquido</b>	
<b>Liquid temperature</b>	0 - 90 °C
<b>Temperatura del líquido</b>	
<b>Température du liquide</b>	
<b>Pressione di esercizio</b>	
<b>Operating pressure</b>	max 6 bar
<b>Presión de trabajo</b>	
<b>Pression de fonctionnement</b>	
<b>MOTORE / MOTOR / MOTOR / MOTEUR</b>	
<b>Motore 2 poli a induzione</b>	3~ 230/400V-50Hz
<b>2 pole induction motor</b>	1~ 230V-50Hz con termoprotettore
<b>Motor de 2 polos a inducción</b>	with thermal protection con protección térmica
<b>Moteur à induction à 2 pôles</b>	avec protection thermique
<b>Classe di isolamento</b>	
<b>Insulation class</b>	F
<b>Clase de aislamiento</b>	
<b>Classe d'isolation</b>	
<b>Grado di protezione</b>	
<b>Protection degree</b>	IP44
<b>Grado de protección</b>	
<b>Protection</b>	

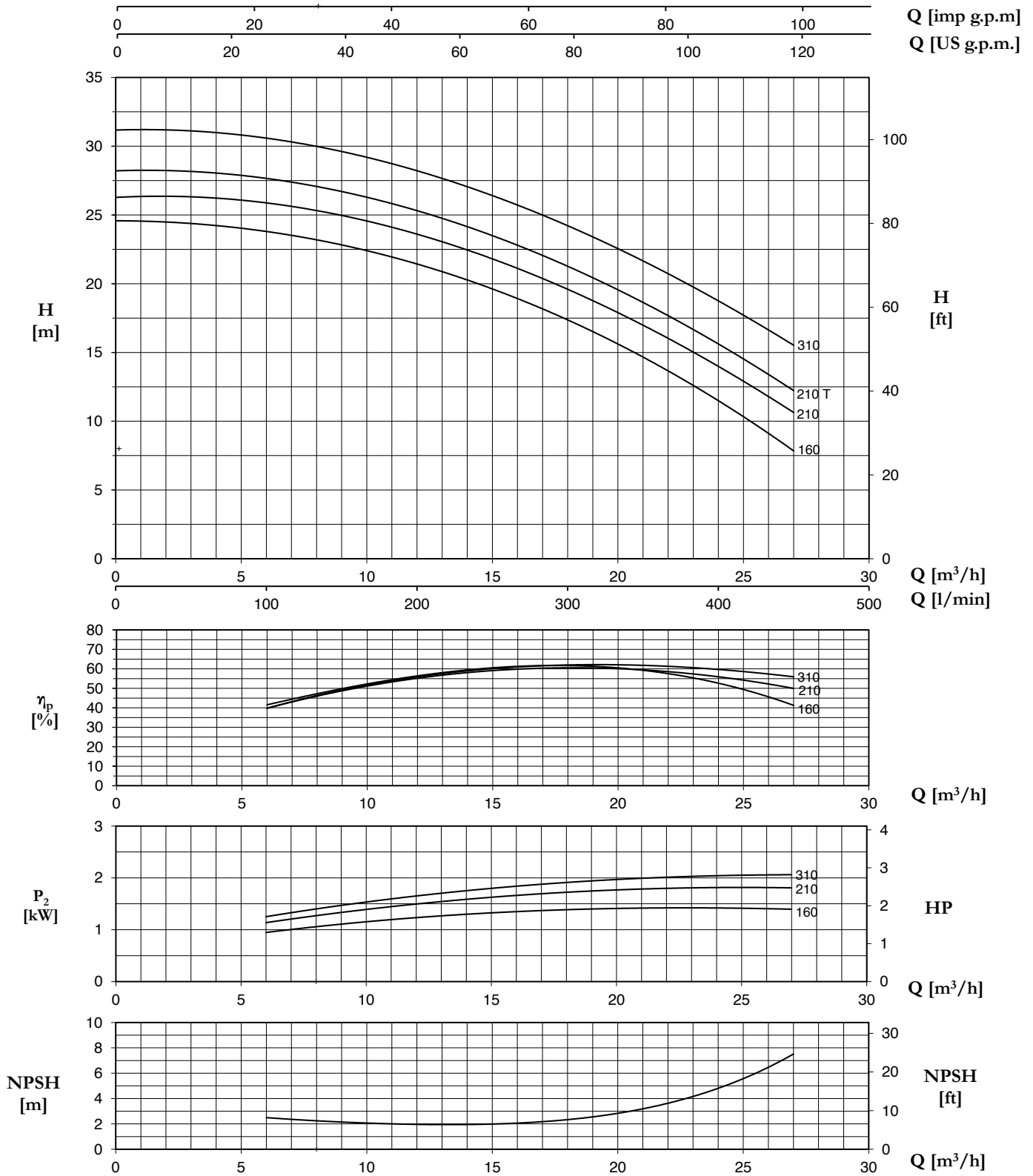

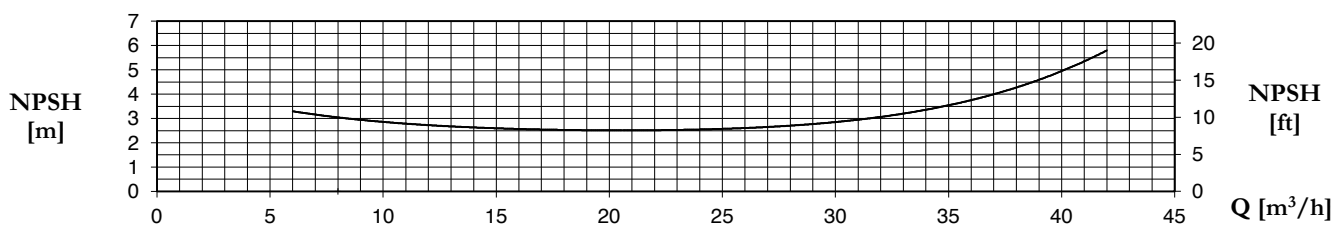
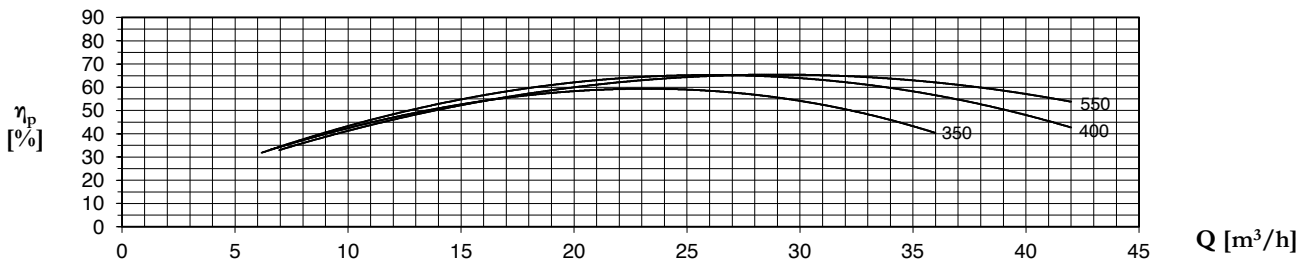
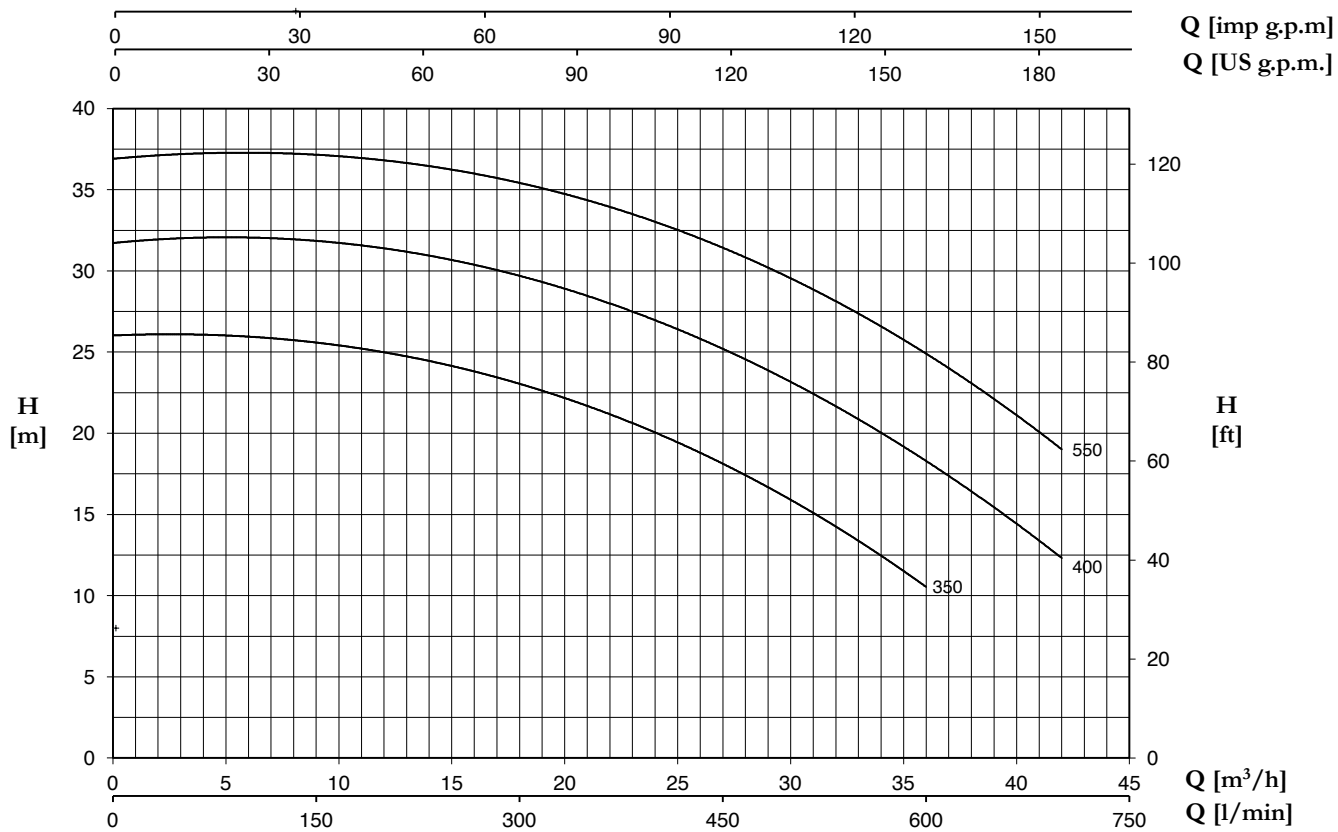

TYPE		P2		P1 (kW)		AMPERE		Q (m³/h - l/min)								
1~	3~	(HP)	(kW)	1~	3~	1~	3~	0	6	9	12	15	18	21	24	27
						50 Hz	50 Hz	0	100	150	200	250	300	350	400	450
								H (m)								
CH 160	CHT 160	1,5	1,1	1,8	1,8	8,3	3,4	24,5	23,9	22,9	21,4	19,5	17,3	14,7	11,6	7,8
CH 210	-	2	1,5	2,1	-	10,1	-	26,3	25,9	25,0	23,6	21,7	19,6	17,1	14,1	10,6
-	CHT 210	2	1,5	-	2,2	-	4,7	28,2	27,6	26,7	25,3	23,5	21,3	18,6	15,6	12,2
CH 310	CHT 310	3	2,2	2,8	2,6	12,4	5,0	31,2	30,5	29,6	28,3	26,4	24,3	21,6	18,6	15,6

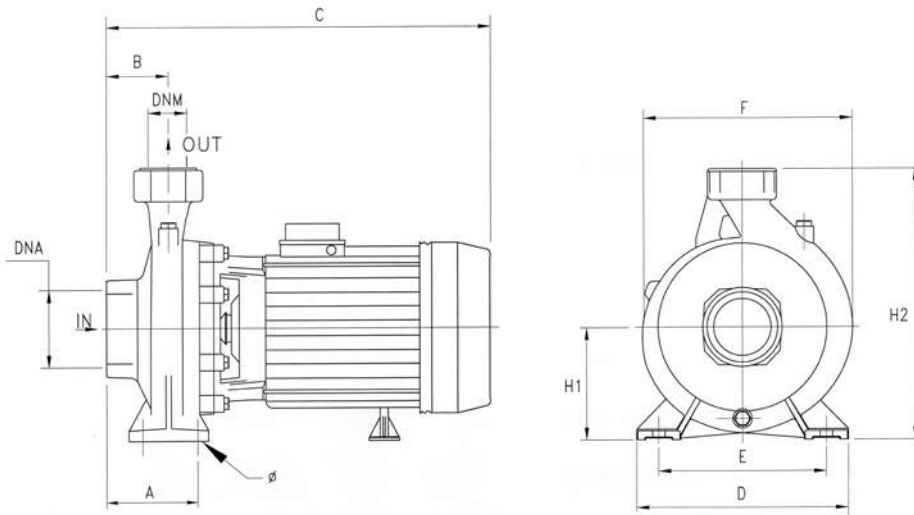

TYPE		P2		P1 (kW)		AMPERE		Q (m³/h - l/min)						
1~	3~	(HP)	(kW)	1~	3~	1~	3~	6	12	18	24	30	36	42
						1x230 V 50 Hz	3x400 V 50 Hz	100	200	300	400	500	600	700
								H (m)						
CH 350	CHT 350	3	2,2	2,95	2,84	13,5	5,1	26	25	23	20	16	10,5	-
CH 400	CHT 400	4	3	4,6	4,2	20,5	7,6	31,8	31,6	29,7	27	23	18,4	12,3
-	CHT 550	5,5	4	-	5,1	-	10	37	37	35,5	33	29,4	25	19



TYPE	DIMENSIONS (mm)														
	A	B	C	D	E	F	Ø	H1	H2	DNA	DNM	I	L		M
CH 160	105	48	370	200	160	215	9.5	110	280	2" G	2" G	390	230	300	22
CH 210	105	48	370	200	160	215	9.5	110	280	2" G	2" G	390	230	300	24
CH 310	105	48	410	200	160	215	9.5	110	280	2" G	2" G	430	230	300	32
CHT 310	105	48	370	200	160	215	9.5	110	280	2" G	2" G	390	230	300	26
CH 350	105	70	425	240	190	240	14	126	306	3" G	2" G	460	270	360	34,5
CHT 350	105	70	385	240	190	240	14	126	306	3" G	2" G	400	270	360	28,5
CH 400	105	70	445	240	190	240	14	126	306	3" G	2" G	460	270	360	38,7
CHT 400	105	70	425	240	190	240	14	126	306	3" G	2" G	460	270	360	33,2
CHT 550	105	70	445	240	190	240	14	126	306	3" G	2" G	460	270	360	38,7

TYPE				
	TRUCK		CONTAINER	
	PALLET (cm)	N° pumps	PALLET (cm)	N° pumps
CH 160-310	85x11x140	40	85x110x195	60
CH 350-550	85x110x150	30	85x110x180	30